



BEYAZLI GRUP



## TESİS FİYATI

**14.775 EURO**

**VESS 4.1 MAKİNE GÜNLÜK (8 SAAT) 2.750 ADET BRİKET ÜRETİM KAPASİTESİNE SAHIPTİR.**

FABRİKA : TRABZON – ERZURUM DEVLET KARAYOLU ÜZERİ 9.Km. YANLIÇA MEVKİİ AKOLUK BELEDİYE KARŞISI – ÇAĞLAYAN / TRABZON / TÜRKİYE  
FABRİKA : +90 462 357 30 62 / OFİS : +90 462 321 07 78 / GSM : +90 549 325 66 67 / Web : [www.vessmakina.com](http://www.vessmakina.com) / Email : [gokhan@beyazligroup.com](mailto:gokhan@beyazligroup.com)



Lütfen Bu Belgeyi Yazdırmadan Önce Çevreyi Düşünün./Please consider the environment before printing this document

## TESİS KURULUM ŞEMASI

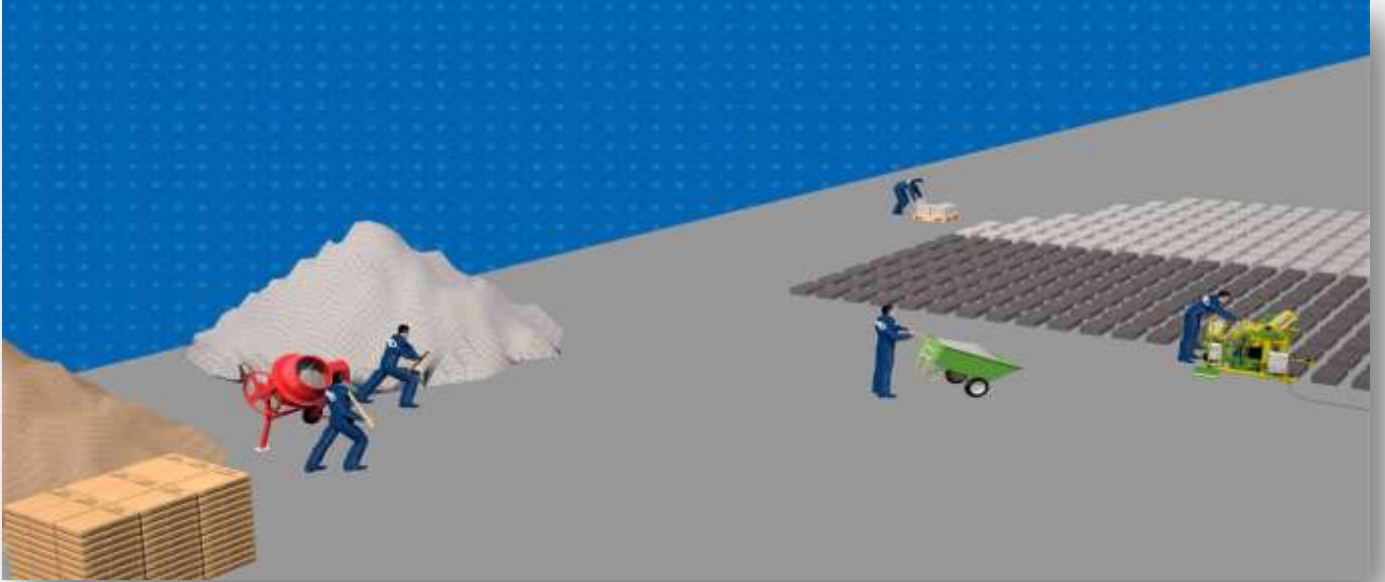

## TESİS AÇIKLAMASI

**VESS 4.1 MANUEL** – BETON ZEMİN ÜZERİNE,PALET GEREKSİNİMİ OLMASIZIN BASKI YAPABİLEN BİR BLOK MAKİNESİDİR.YÜRÜYÜŞ KABİLİYETİ SAYESİNDE KENDİNE BASKI YAPABİLECEK ALANI OLUŞTURMA ÖZELLİĞİNE SAHİPTİR.ÖNCEDEN HAZIRLANMIŞ HARCİ İÇİNE ALARAK ÜZERİNE BAĞLANAN HER TÜRLÜ BRİKET-ASMOLEN-STRAFORLU BRİKET VE BAHÇE BORDÜRLERİN ÜRETİMİNİ YAPABİLMEKTEDİR.**MANUEL** İŞLETİM SİSTEMİNE GÖRE DİZAYN EDİLMİŞTİR.24 SAAT ÇALIŞMA ESASINA GÖRE TASARLANMIŞTIR.FARKLI OTOMASYON MODELLERİ VE KAPASİTELERDE İMALATIMIZ VARDIR.DETAYLI BİLGİ İÇİN LÜTFEN SİZE EN YAKIN MÜŞTERİ TEMSİLCİLİĞİMİZ İLE İRTİBATA GEÇİNİZ.

“NUMARALANDIRILMIŞ ÖRNEK KURULUM ŞEMASINA” GÖRE HAZIRLANMIŞ ÜRÜN LİSTESİ VE FİYATLARI AŞAĞIDA BELİRTİLMİŞTİR. ÖRNEK ŞEMA ANAHTAR TESLİMİ, TAM BİR TESİS OLARAK TASARLANMIŞTIR. İÇERİĞİNDE BULUNAN EKİPMANLAR OPSİYONEL OLARAK İSTEĞE GÖRE ÇIKARILABİLİR,VEYA ADETLERİ AZALTILABİLİR – ARTTIRILABİLİR.(Lütfen web sitemizi ziyaret edin ve teklif isteyin)

BU ÖZELLİKLERDE OLAN BİR TESİS İÇİN TAVSİYE ETTİĞİMİZ KURULUM – DİNLENDİRME VE STOK SAHASI MİNİMUM **1.500 m<sup>2</sup>** OLMALIDIR.ÇATI KAPATMA ZORUNLULUĞU YOKTUR.TAVSİYE EDİLEN ÜRETİM ALANI (BETON ZEMİN) TOPLAM SAHANIN EN AZ **1/2** Sİ ORANINDA OLMALIDIR.

### 4.1 MANUEL MAKİNE SEVKİYAT HACMİ

**1 ADET 20'LİK HQ KONTEYNER'DİR.**





## TESİS KURULUM ŞEMASINA GÖRE ÜRÜN AÇIKLAMASI

### (01) – VESS 4.1 MANUEL (YUMURTLAYAN) BRİKET MAKİNESİ



### MAKİNE GENEL TANITIMI

- ▶ AZ PERSONEL İLE YÜKSEK ÜRETİM KAPASİTESİNE SAHIPTİR. ▶ HER TÜRLÜ YEDEK PARÇASI KOLAYLIK İLE BULUNABİLİR. ▶ ELEKTRİK TÜKETİMİ MİNİMUM SEVİYEDEDİR. ▶ İSTENİLEN YERE KOLAYCA TAŞINIP KURULABİLİR. ▶ SİPARİŞ ALINAN ŞANTİYE SAHASINDA DAHİ ÜRETİM YAPMANIZA OLANAK SAĞLAR. ▶ SESSİZ MOTOR POMPASI İLE AZ GÜRÜLTÜ ÇIKARIR. ▶ YANMAZ ELEKTRİK KABLOSUNA SAHIPTİR. ▶ KOLAY VE KISA SÜREDE KALIP DEĞİŞTİRİLEBİLİR. ▶ MONTAJ İÇİN TEKNİK YARDIM GEREKTİRMEZ. ▶ İNCE AGREGA İLE ÜRETİM YAPILDIĞINDAN PÜRÜZSÜZ YÜZEYLİ TAŞLAR ÜRETİR. ▶ EKLENEBİLEN OPSİYONEL EKİPMANLAR SAYESİNDE FABRİKASYON ÜRETİM İMKANI SAĞLAR. ▶ İSTEĞE GÖRE SABİT ÇALIŞABİLİR. (PALETLİ ÜRETİM YAPABİLME KABİLİYETİNE SAHIPTİR ) ▶ YARI OTOMATİK - TAM OTOMATİK SİSTEME DÖNÜŞTÜRÜLEBİLİR.





## MAKİNE ÇALIŞMA ŞEKLİ

▶ YÜRÜYÜŞ HAREKETİ OTOMATİK	▶ VİBRASYONU MANUEL (START – STOP’LU)
▶ ÜRÜN YÜKSEKLİK SABİTLEYİCİSİ	▶ HAREKET SÜRESİNCE ÇALAN İKAZ SİRENİ
▶ ERKEK KALIP HAREKETİ MANUEL	▶ AYARLI BASKI SİSTEMİ
▶ DÖNÜŞ HAREKETİ OPERATÖR KUMANDALI	▶ HARÇ YÜKLEMESİ MANUEL
▶ FAZLA GELEN HARÇ İÇİN ATIK TABLASI	▶ YAĞ SEVİYE GÖSTERGELİ
▶ ÖMÜR BOYU AŞINMAZ TEKERLEKLER	▶ GÜVENLİK İÇİN ACİL STOP BUTONU
▶ HİDROLİK SİSTEMİ HAVA FİLTRELİ - GERİ DÖNÜŞLÜ	▶ ÜRETİM YAPACAĞI ALANI KENDİ TEMİZLER

## İSTEĞE GÖRE İLAVE EDİLEBİLECEK EKİPMANLAR

KABARTMA YÜZEYİ OLAN TAŞ KALIBI VE EKİPMANI (HER BASKIDA TEK ÜRÜN ÇIKARTIR.)

MANUEL TOPLAMA ROBOTU // YERE SABİTLEME APARATI (PALETLİ SİSTEME DÖNÜŞEBİLİR)

STRAFORLU BRİKET KALIBI // JENERATÖR // KOMPRESÖR // TRANSPALET

TENTE ( MAKİNAYI DIŞ ETKENLERDEN KORUMAK İÇİN )

220V YADA 380V İLE ÇALIŞAN MOTOR SEÇENEKLERİ



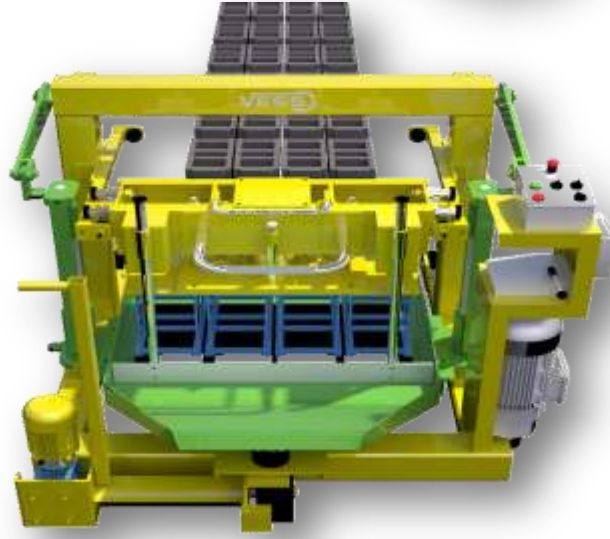

## MAKİNE TEKNİK DETAYLARI

KUMANDA ŞEKLİ	MANUEL	HİDROLİK TANKI	70 Lt
MOTOR ADETİ	3 ADET	HİDROLİK BASINCI	65 Bar
TOPLAM MOTOR GÜCÜ	3.2 Kw	TOPLAM AĞIRLIK	600 Kg
VİBRASYON ADETİ	TEK VİBRO MOTOR	DIŞ ÖLÇÜLERİ	145x135x110 cm
VİBRASYON GÜCÜ	475 Kg	ELEKTRİK KABLOSU (SOKETLİ)	50 mt
VİBRASYON ÇEVİRİM SÜRESİ	20 SANİYE	PERSONEL SAYISI (ÜRETİM İÇİN)	4 Kişi
SIKIŞTIRMA TİPİ	TORSİYON (YAY İLE SIKIŞTIRMA)	ÜRETİM ALANI (TAVSİYE EDİLEN)	675 m <sup>2</sup> (15 x 45)
ÜRETTİĞİ MAMULLER	18-20 cm YÜKSEKLİK	AGREGA (TAVSİYE EDİLEN)	5 mm

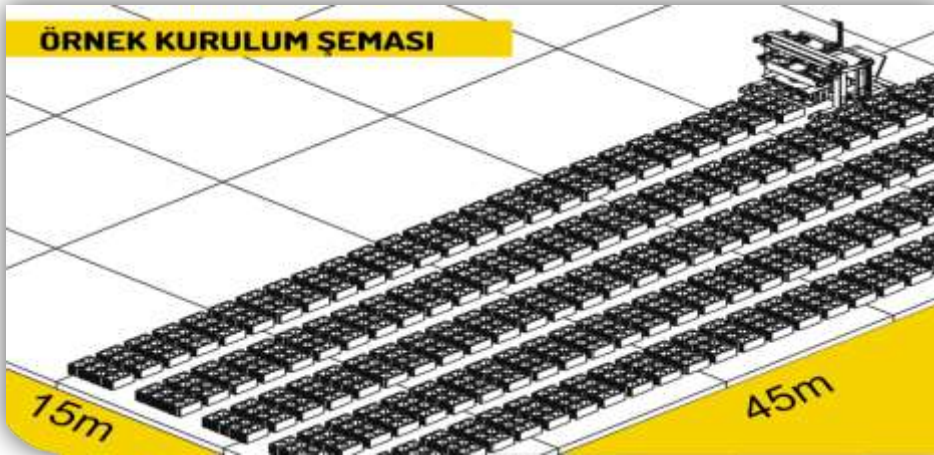

**NOT:** ÜRETİM SAHASI YAYILIMI,  
**MANUEL MAKİNELER:** ÖNE DOĞRU 5  
 cm LİK ARA İLE-YANA DOĞRU 35 cm LİK  
 ARA İLE BOŞLUK VEREREK YUMURLAR.  
**OTOMATİK MAKİNELER** ÖNE DOĞRU 20  
 cm LİK ARA İLE-YANA DOĞRU 35 cm LİK  
 ARA İLE BOŞLUK VEREREK YUMURLAR.  
 MANUEL MAKİNELER İÇİN EN AZ 15x45  
 METRELİK BİR ALAN BETON YAPILMASI  
 TAVSİYE EDİLİR.



## BİR BASKIDA ÜRETİM KABİLİYETİ



(6 ADET)

**BRİKET - 10 LUK**  
10 x 40 x h:20



(2 ADET)

**BRİKET - 30 LUK**  
30 x 40 x h:20



(5 ADET)

**BRİKET - 12 LİK**  
12 x 40 x h:20



(4 ADET)

**ASMOLEN - 20 LİK**  
20 x 40 x h:20



(5 ADET)

**BRİKET - 15 LİK**  
15 x 40 x h:20



(4 ADET)

**STRAFORLU - 20 LİK**  
20 x 40 x h:20



(4 ADET)

**BRİKET - 20 LİK**  
20 x 40 x h:20



(1 ADET)

**KABARTMA TAŞ - 20 LİK**  
20 x 40 x h:20



(3 ADET)

**BRİKET - 25 LİK**  
25 x 40 x h:20



(2 ADET)

**BORDÜR - 50 LİK**  
12 x 50 x h:20

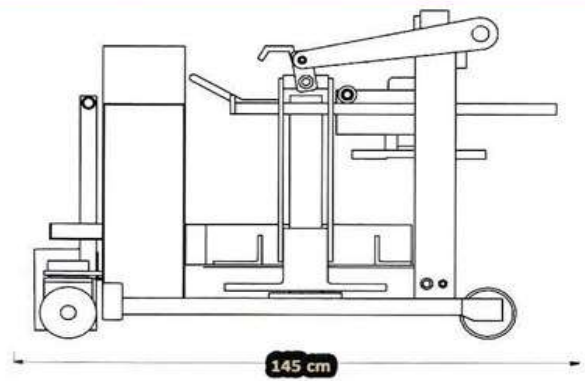
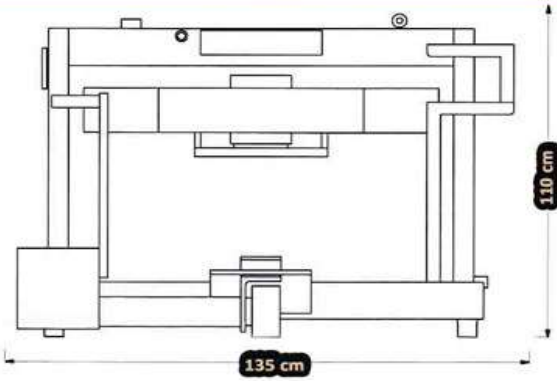

## (02)– HARÇ KARIŞTIRICI BETONİYER MİKSER



BASKI YAPILACAK ÜRÜN İÇİN GEREKEN KARIŞIMIN (HARCIN), HAZIRLANDIĞI EKİPMANDIR.380 – 400 Lt. KARIŞIM KAPASİTESİNE SAHİPTİR.DEĞİŞTİRİLEBİLEN TAHRİK DİŞLİSİ MEVCUTTUR.ÇELİK KİRİŞLE TAKVİYE EDİLMİŞ TAMBUR TABANI VARDIR.GÜVENLİ ELEKTRİK İZOLASYONU İLE KORUNMAKTADIR.İÇ KOLLARI HOMOJEN ŞEKİLDE KARIŞIM YAPAR,KALİTELİ HARÇ ELDE EDİLİR.TAMBURUN ÜST VE ALT KISMI AYRI AYRI DEĞİŞTİRİLEBİLMEKTEDİR.BETON MİKSERİN TAHRİK VE TAMBUR YATAKLARI KALİTELİ RULMANLARDAN İMAL EDİLMİŞTİR.KONİK TAMBUR SAYESİNDE KOLAY BOŞALTMA MÜMKÜNDÜR.MİKSERİN BAKIMA İHTİYACI YOKTUR.

## (03)– HARÇ TAŞIMA ARABASI



BASKI YAPILACAK ÜRÜN İÇİN GEREKLİ KARIŞIMI (HARCI) MİKSERDEN ALARAK MAKİNEYE TAŞIYAN EKİPMANDIR.

### ÜRÜN ÖZELLİKLERİ

- BORU KALINLIĞI 32/1.50 MM
- KASA KALINLIĞI 0,80 MM
- ÖZEL KASA KENARI BÜKÜMLÜ SİSTEM
- 85 LT. KASA HACMİ
- DUBLEX TEKERLEKLİ
- TEKNE / ST 52-A1 ÇELİK SAC
- DEMONTE (CİVATALI) SİSTEM





### (04)– SİRAL ELEKTRİK AKTARMA KABLOSU (SOKETLİ)



ELEKTRİK ŞEBEKESİNDEN GELEN ENERJİYİ MAKİNEYE AKTARAN KABLO DÜZENEGİDİR. ÜRETİM YAPILAN ALANA YETECEK MİKTARDA KULLANILMIŞTIR. MAKİNEİNİN YÜRÜYÜŞ HAREKETLERİNDEN ETKİLENMEMESİ İÇİN SİRAL KORUMASI MEVCUTTUR. BU KORUMA SAYESİNDE SAHA İÇERİSİNDE İSTENİLEN YERE RAHATÇA HAREKET ETTİRİLEBİLİR. MEKANİK STRESE KARŞI DAYANIKLIDIR. SİRAL KABLONUN EN ÖNEMLİ ÖZELLİĞİ, BULUNDUKLARI ORTAMDA KARIŞIKLIĞA SEBEBİYET VERMEMEK İÇİN GERİ ÇEKİLEBİLEN ÖZELLİKTE OLMALARIDIR.

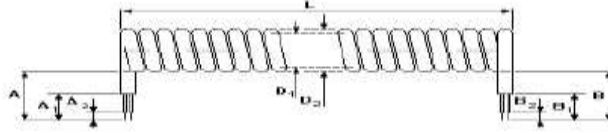

### (05)– HARÇ YAYMA KÜREĞİ



MİKSERDEN EL ARABASI YARDIMI İLE TAŞINAN HARCİ, MAKİNEİNİN KALIP HAZNESİNE ÖZEL TASARIMI SAYESİNDE DOLDURMAYA YARAYAN EKİPMANDIR. SAP SİSTEMİ KOLAY TUTMAYA VE HAREKET ETTİRMEMEYE UYGUN ŞEKİLDE DİZAYN EDİLMİŞTİR. UÇ BÖLÜMÜNDE KULLANILAN METALİN 90 DERECELİK EĞİMİ İLE KALIP İÇERİSİNE KISA SÜREDE HARCIN YERLEŞTİRİLMESİNİ SAĞLAR. SÜREKLİ HARÇ İLE TEMAS HALİNDE OLDUĞUNDAN AŞINMAYA DAYANIKLI VE HAFİF MALZEMELER TERCİH EDİLMİŞTİR.

### (06) – BRİKET KALIBI MUHTELİF ÇEŞİTLERİ ( ST 52 )

**ÇELİK KONSTRÜKSİYON KALIPLAR** : TASARIMI YAPILMASINA MÜTEAKİP AŞINMAYA MUKAVİM ÖZEL SAÇLAR KULLANILARAK ÇELİK KONSTRÜKSİYON SİSTEMİ İLE İSTENİLEN ÖLÇÜYE GETİRİLİR. BORDÜR KALIPLARI İÇİN BASKI BIÇAKLARI CK 45 ÖZEL SAÇLARDAN TALAŞ KALDIRARAK İŞLENDİKTEN SONRA İNDÜKSİYON İLE SERTLEŞTİRİLİP KULLANIMA HAZIR HALE GETİRİLİR.



**BETON-BİMS BLOKLAR**

### (07) – ELEKTRİK ÜNİTESİ / OTOMASYON



**MAKİNA ELEKTRİK PANOSU**; TÜM PARÇALARININ TEK YERDE TOPLANDIĞI ENERJİ PANOSUDUR. OPERATÖRÜN YAPACAĞI İŞLEM SIRASINA GÖRE DİZAYN EDİLMİŞTİR. ACİL DURUMLAR İÇİN ACİL STOP BUTONLARI İLE KORUMA ALTINA ALINMIŞTIR. KULLANILAN MALZEMELERDE **BOSCH VE SIEMENS** MARKALI ÜRÜNLER TERCİH EDİLMİŞTİR. HER MOTOR İÇİN SİGORTASI MEVCUTTUR SÜRELİ KOMUTLAR İÇİN SCHNEIDER MARKA ZAMAN ROLESİ KULLANILMIŞTIR.



## BAZI KALIP MODELLERİMİZ



## TİCARİ ŞARTLAR

- **KOD : V-039** OLAN BU KAMPANYAMIZ 30.06.2019 TARİHİNE KADAR GEÇERLİDİR.TESLİMAT SÜRESİ ; MAKSİMUM 21 İŞ GÜNÜDÜR.OPERATÖR EĞİTİMİ ; EĞİTİM VE OPERATÖRLÜK SERTİFİKASI ÜCRETSİZ OLARAK VERİLECEKTİR
- **ALTYAPI PROJESİ** ; GEREKLİ KEŞİF VE İNCELEMELER YAPILARAK ÜCRETSİZ OLARAK VERİLMEKTEDİR.
- **DEVREYE ALMA VE TEST ÜRETİMİ** ; MONTAJ EKİBİNİN VİZE (GEREKLİ ÜLKELER İÇİN) – ULAŞIM - TRANSFER VE KONAKLAMA MASRAFLARI İLE HİDROLİK ÜNİTEDE KULLANILACAK YAĞ ALICIYA AİTTİR.
- **NAKLİYE** ; KAMPANYA FİYATLARI FABRİKA TESLİMİ (EX WORK)'DÜR.NAKLİYE VE TÜM SİGORTA MASRAFLARI ALICIYA , YÜKLEME MASRAFLARI SATICIYA AİTTİR.FİRMAMIZ MÜŞTERİLERİNE YAPILACAK SEVKİYATLARDA TÜM LOJİSTİK DESTEĞİ SAĞLAMAKTADIR.**VERGİ** ; YURTIÇİ SATIŞLARDA % 18 , TEŞFİK VE LEASİNGDE % 1 OLARAK UYGULANIR. YURTDİŞİ SATIŞLARDAN VERGİ TALEP EDİLMEZ.
- **ÖDEMELER** ; SİPARİŞTE RESMİ SÖZLEŞME DÜZENLENEREK % 30 LUK BÖLÜMÜ PEŞİN ,% 30 LUK BÖLÜMÜ ARA ÖDEME VE % 40 LUK BÖLÜMÜ TESLİMATTA VE BANKA YOLU İLE TAHSİL EDİLİR. İMALATLARIMIZIN TÜMÜ AKREDİTİF - BANKA KREDİSİ VE LEASİNG YOLU İLE SATIŞLARA UYGUNDUR.
- **SÖZLEŞMELERİMİZ** ; YURTIÇİ SATIŞLARDA SANAYİİ VE TİCARET ODASI – YURTDİŞİ SATIŞLARDA İHRACATÇILAR BİRLİĞİ TARAFINDAN ONAYLI OLARAK DÜZENLENMEKTE'DİR.ULUSLARARASI NİTELİĞE VE GEÇERLİLİĞE SAHİPTİR.
- **GARANTİ** ; İMALAT HATALARINA KARŞI TÜM ÜRÜNLERİMİZ 2 YIL GARANTİLİDİR.İSTEĞE GÖRE % 5 FİYAT FARKI İLE GARANTİ SÜRESİ **2 + 3 = 5** YILA UZATMA İMKANI VARDIR.
- **SERVİS VE YEDEK PARÇA** ; MUHTEMEL ARIZALARDA YURT İÇİ MÜDAHALE SÜREMİZ MAKSİMUM 48 SAAT – YURT DIŞI MÜDAHALE SÜREMİZ, DÜNYANIN HER YERİNE MAKSİMUM 72 İLE 120 SAAT ARALIĞINDADIR. DAVETİYE GEREKEN ÜLKELER İÇİN BELİRTİLEN BU SÜRELER GEÇERLİ DEĞİLDİR.GARANTİ TAAHHÜTLERİMİZ RESMİ SÖZLEŞME İLE İMZA ALTINA ALINMAKTADIR.



## FOTO GALERİ



FABRİKA : TRABZON – ERZURUM DEVLET KARAYOLU ÜZERİ 9.Km. YANLIÇA MEVKİİ AKOLUK BELEDİYE KARŞISI – ÇAĞLAYAN / TRABZON / TÜRKİYE  
FABRİKA : +90 462 357 30 62 / OFİS : +90 462 321 07 78 / GSM : +90 549 325 66 67 / Web : [www.vessmakina.com](http://www.vessmakina.com) / Email : [gokhan@beyazligroup.com](mailto:gokhan@beyazligroup.com)



Lütfen Bu Belgeyi Yazdırmadan Önce Çevreyi Düşünün./Please consider the environment before printing this document

## İLETİŞİM KANALLARIMIZ

TÜRKİYE 	
İlgili:	Gökhan Özdemir
İletişim 1:	+90 (549) 325 66 67
İletişim 2:	+90 (543) 868 53 04
E-mail:	gokhan@beyazligroup.com

RUSYA 	
İlgili:	Tolga Kalelioğlu
İletişim 1:	+90 (549) 325 66 62
İletişim 2:	+90 (462) 321 07 78
E-mail:	tolga@beyazligroup.com

FRANSA 	
İlgili:	Mohamed Thiam
İletişim 1:	+90 (549) 325 66 60
İletişim 2:	+90 (462) 321 07 78
E-mail:	mohamed@beyazligroup.com

LİBYA 	
İlgili:	Mouad Mazour
İletişim 1:	+218 (911) 620 035
İletişim 2:	+90 (541) 868 54 59
E-mail:	mouad@beyazligroup.com

GÜRCİSTAN 	
İlgili:	Lasha Gabaidze
İletişim 1:	+995 (571) 912 626
İletişim 2:	+90 (549) 325 66 64
E-mail:	lasha@beyazligroup.com

SUUDİ ARABİSTAN 	
İlgili:	Abdurrahim Temur
İletişim 1:	+90 (544) 549 41 99
İletişim 2:	+90 (462) 321 07 78
E-mail:	temur@beyazligroup.com

AZERBAJYAN 	
İlgili:	Anar Nazarov
İletişim 1:	+994 (702) 002 677
İletişim 2:	+90 (549) 325 66 61
E-mail:	gokhan@beyazligroup.com

UKRAYNA 	
İlgili:	Tolga Kalelioğlu
İletişim 1:	+90 (549) 325 66 62
İletişim 2:	+90 (462) 321 07 78
E-mail:	tolga@beyazligroup.com

UMMAN 	
İlgili:	Abdurrahim Temur
İletişim 1:	+90 (544) 549 41 99
İletişim 2:	+90 (462) 321 07 78
E-mail:	temur@beyazligroup.com

CEZAYİR 	
İlgili:	Mouad Mazour
İletişim 1:	+90 (541) 868 54 59
İletişim 2:	+90 (462) 321 07 78
E-mail:	mouad@beyazligroup.com

AFRİKA 	
İlgili:	Abdoul Wahabou
İletişim 1:	+90 (549) 325 66 70
İletişim 2:	+90 (462) 321 07 78
E-mail:	abdoul@beyazligroup.com

FAS 	
İlgili:	Soumia Boukebir
İletişim 1:	+90 (549) 325 66 69
İletişim 2:	+90 (462) 321 07 78
E-mail:	soumia@beyazligroup.com



[www.beyazligroup.com](http://www.beyazligroup.com) /// [www.vessmakina.com](http://www.vessmakina.com) /// [info@beyazligroup.com](mailto:info@beyazligroup.com)

FABRİKA : TRABZON – ERZURUM DEVLET KARAYOLU ÜZERİ 9.Km. YANLIÇA MEVKİİ AKOLUK BELEDİYE KARŞISI – ÇAĞLAYAN / TRABZON / TÜRKİYE  
 FABRİKA : +90 462 357 30 62 / OFİS : +90 462 321 07 78 / GSM : +90 549 325 66 67 / Web : [www.vessmakina.com](http://www.vessmakina.com) / Email : gokhan@beyazligroup.com



Lütfen Bu Belgeyi Yazdırmadan Önce Çevreyi Düşünün./Please consider the environment before printing this document